

# Neon Specification

**ANFS1220DMX**

# Neon Specification

ANFS1220DMX

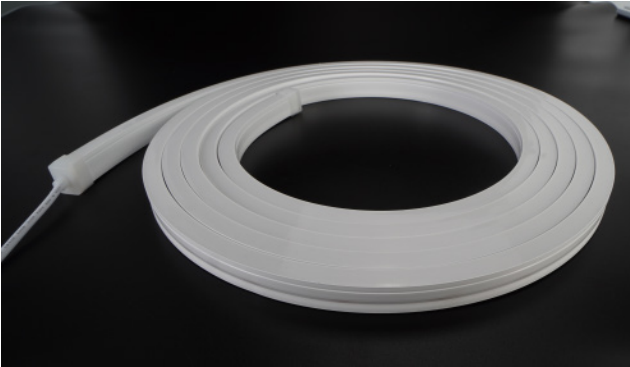

## Feature

1. Side bending design, uniform light, Suitable for indoor and outdoor decorative lighting, architectural outline lighting, etc.
2. Silicone integrated extrusion technology, IP67 rate.
3. Using the internationally accepted DMX512 transmission protocol, matching most of the market DMX512 controller.
4. Using high quality gas silica gel, yellowing resistance, UV resistance, salt and alkali resistance, high temperature resistance, flame reardant.

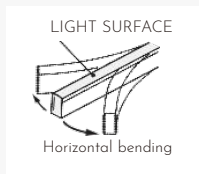

Min. Bending Radius  
60mm / 2.36in

Ambient Working Temperature  
-40 ~ 55°C

Storage Temperature  
-40 ~ 60°C

Min. Cutting Length  
125mm @White

Min. Cutting Length  
100mm@RGB

Min. Cutting Length  
100mm @RGBW

## Electrical & Output Data

Model No.	ANFS1220DMX						
Step length (mm)	125mm (@white)	100mm(@RGB)	100mm(@RGBW)				
Voltage (v)	24V						
Color	2700K	3000K	3500K	4000K	6000K	RGB	RGBW
Ra	90						
Beam Angle(°)	110						
Power (w/m)	12,5W(@white)	14,4W(@RGB)	18W(@RGBW)				
Lumen(lm/m)	188 @ Ra90 @ 4000K	86 @ RGB	180 @ Ra90 @ RGBW				
IP rate	67						
Installation	Mounting Clips / Aluminum Profiles						

The electrical data provided on the each product pages are for reference only; the data values are not guaranteed. Specification may be subject to change without announcement.

## Illuminance Distribution

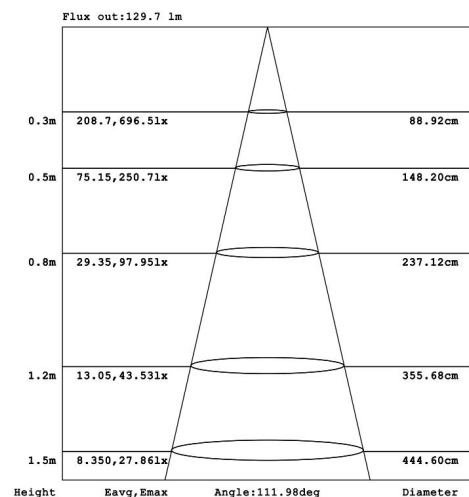
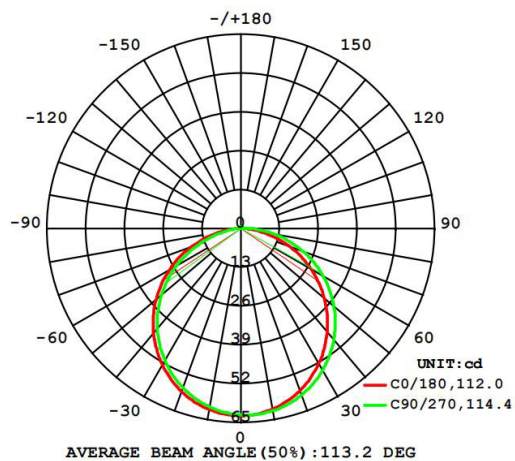

## Light efficiency & Lumen Output

Item No.	Color temperature	Ra	Beam angle	Luminous flux (lm/m)	Luminaire efficacy (lm/W)	Power (W/M)
ANFS1220DMX12W24	2700K	90	110°	188	15	12.5W/M
ANFS1220DMX12W06	3000K	90	110°	188	15	12.5W/M
ANFS1220DMX12W08	4000K	90	110°	200	16	12.5W/M
ANFS1220DMX12W04	6000K	90	110°	200	16	12.5W/M
ANFS1220DMXRGB	RGB	-	110°	19(@R) 43(@G) 10(@B) 86(@RGB)	4(@R) 9(@G) 2(@B) 6(@RGB)	144W/M
ANFS1220DMXRGBWXX	RGBW	90	110°	18(@R) 45(@G) 14(@B) 63(@W3000K) 180(@RGBW)	4(@R) 10(@G) 3(@B) 14(@W3000K) 10(@RGBW)	18W/M

## Dimensions & available lengths

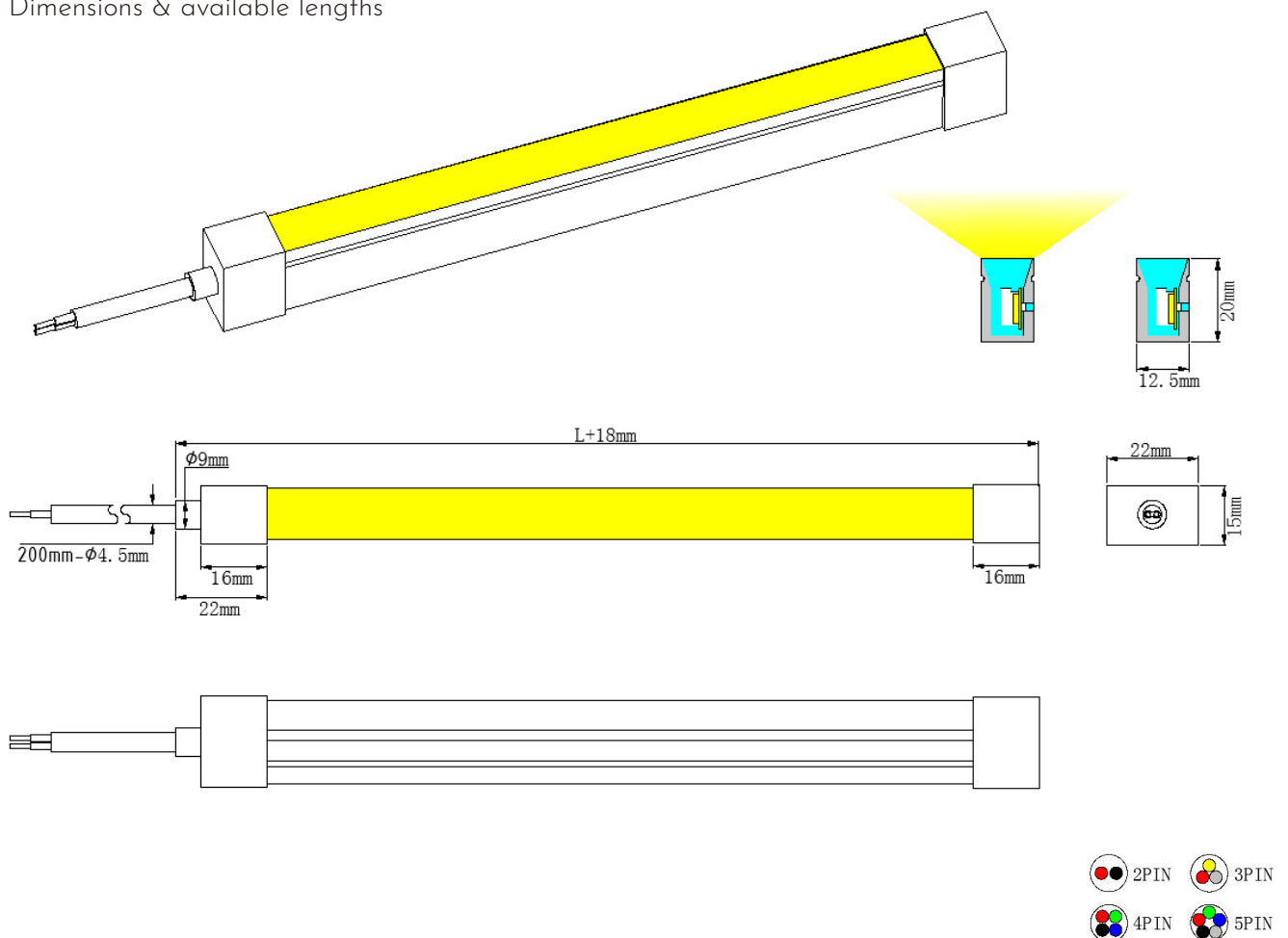

Note: The length of "L" is the length of the light strip, which is an integer multiple of the minimum cutting length.

## Max. Running Length

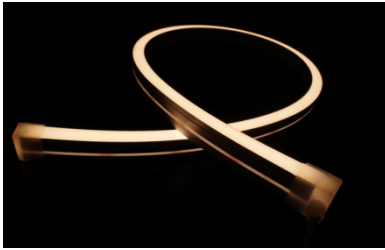

Type IP Rate	White 67 12.5Watt	RGB 67	RGBW 67
Item Code	Single-end	Single-end	Single-end
max.length (m)	3.8% @5M	R: 1.21% @5M G: 1.1% @5M B: 1.12% @5M RGB: 1.2% @5M	R: 8.28% @5M G: 2.26% @5M B: 8.43% @5M W: 1.7% @5M

**Note:**

1. Above conclusion is based on voltage drop testing result of the light with 200mm cable only.
2. The maximum running length is based on the light in static full loading status.
3. Above running length is only the light length excluding lengths of connectors.
4. The delivery length might be subject to the maximum packing length.

## ANFS1220DMX Mounting Profile

Name/Item Code

Picture

Installation Way

Install aluminum clips  
ANFZ1220A04  
L30\*W14.1\*H20mm

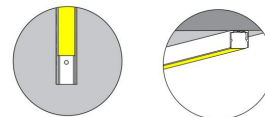
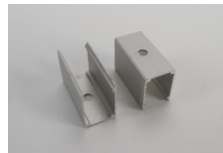

Install aluminum clips kit  
ANFZ1220A02  
L30\*W14.8\*H23.2mm



Aluminum Profile  
ANFZ1220A03  
L1000\*W14.1\*H20mm

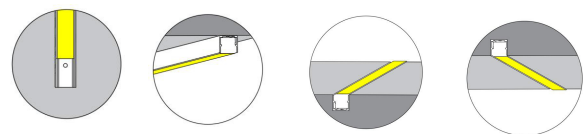

Aluminum Profile Kit  
ANFZ1220A01  
L1000\*W14.8\*H23.2mm



Bendable Serrated Profile  
ANFZ1220A06  
L1000\*W13\*H18.4mm

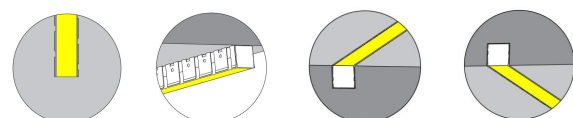

# ANFS1220DMX Wiring Diagram

Please use a constant voltage power supply with corresponding output voltage, and rated wattage of the power supply shall be 25% more than the actual power consumption of light to increase its life expectancy;

1. This wiring diagram is using the mains of AC 220-240V with brown and blue wires as an example, and please connect with the corresponding live and neutral wires for other mains electricity;
2. Dimming frequency ranges from 100Hz to 2000Hz, and 500Hz is recommended.

**Light Length:**

The length of the longest single light in parallel connection or sum of lights in series connection.

**Cable Length:**

The length of an electrical cable between power output end and light input end, and the cables for serial interconnection are inclusive.

**How to Minimize Voltage Drop:**

1. Please ensure the cable length is not more than the table "Max. Cable Length" according to light length and its wire gauge.
2. Please ensure the light length is less than the cable "Max. Running Length Single-end Feed".

PVC wire & M12 connector connection mode:

"+": Red wire "A": Blue wire "B": White wire "PI/PO": Green wire "GND": Black wire

## Single-end Feed

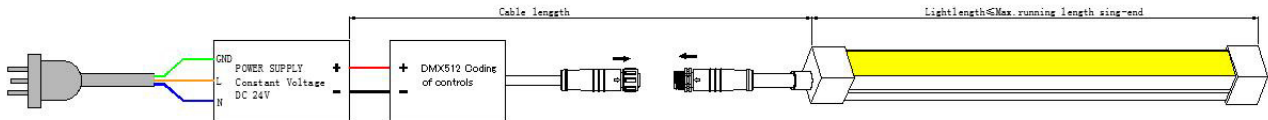

## Double-end Feed

The following wiring diagram with double-end feed to run length that is longer than max. running length for single-end feed but less than twice the value.

### WARNING

Please ensure the polarity connection is correct on both ends, and short circuit might occur if powering the light from both ends with reverse polarity. It is not recommended to feed both ends of light with two separated power supplies, which would lead to overloading and overheating problem if either power supply is failed.

M12 connector connection mode: "+": Red wire "A": Blue wire "B": White wire "PI/PO": Green wire "GND": Black wire

**Light Length:**

The length of the longest single light in parallel connection or sum of lights in series connection.

**Cable Length:**

The length of an electrical cable between power output end and light input end, and the cables for serial interconnection are inclusive.

**How to Minimize Voltage Drop:**

1. It is optimal to position the power supply in the middle of a single light or multiple lines in daisy chain to keep the equivalent cable length on both ends for double-end feed.
2. Please ensure the cable length is not more than the table "Max. Cable Length" according to the half of light length and its wire gauge.
3. Please ensure the light length is less than the table "Max. Running Length Double-end Feed".

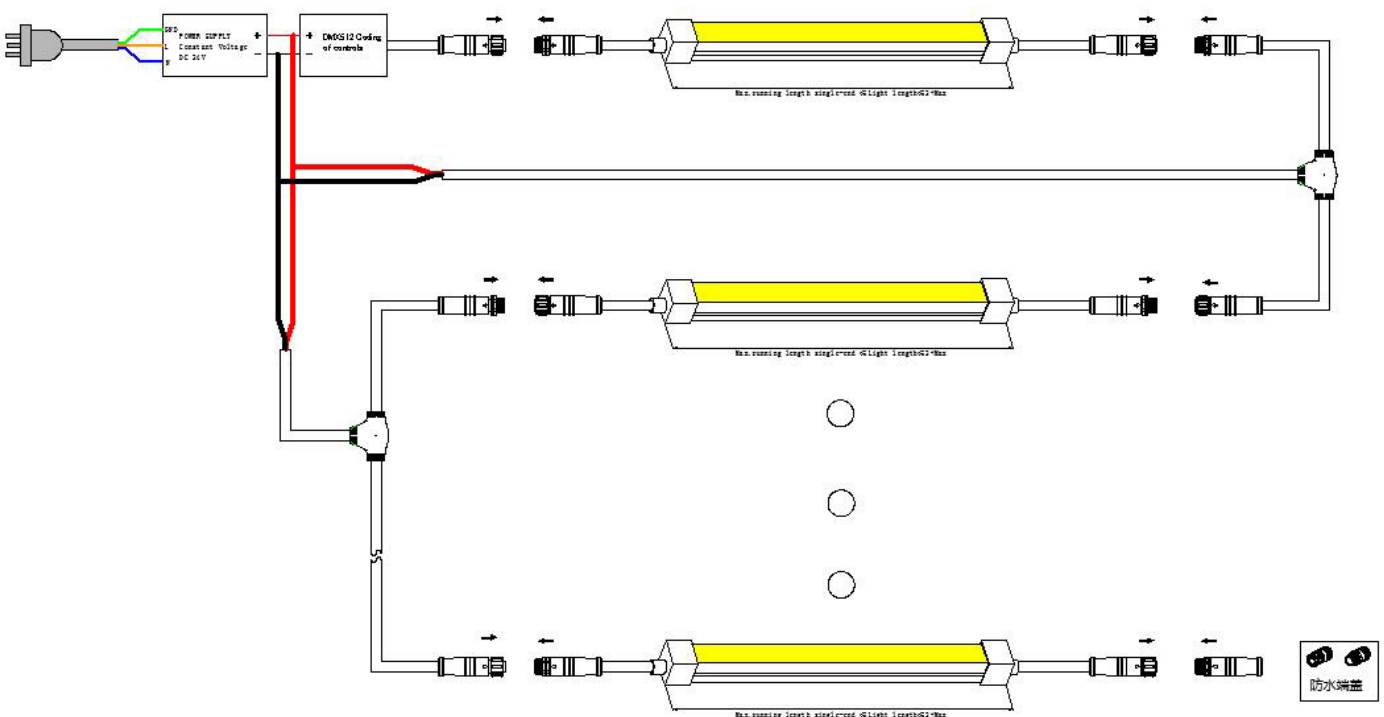



### ConnectorType

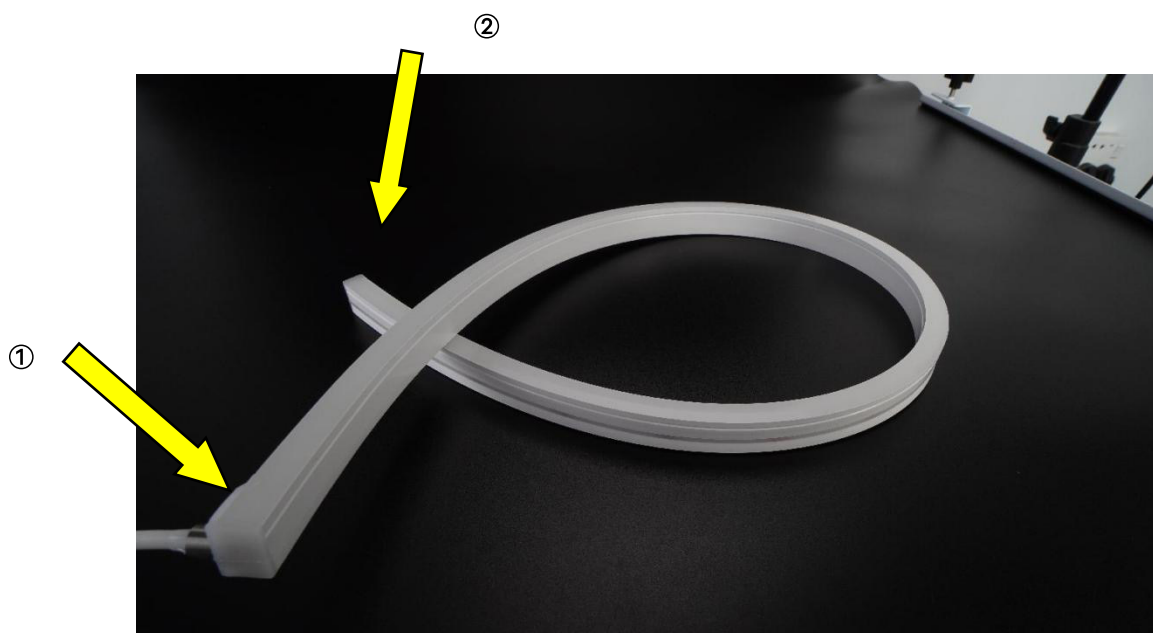

---

#### 1 Outlet waterproof End Cap

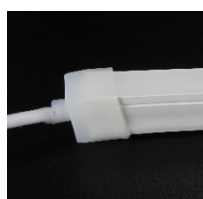

Top

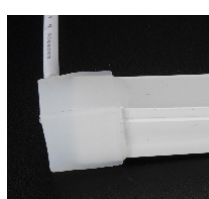

Right



Bottom



Injection-moulded

---

2 No outlet waterproof End Cap

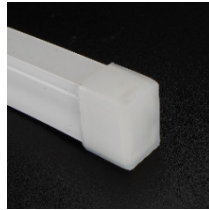

End cap  
ANFZ1220A13

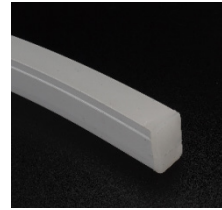

Injection-moulded

Dimension: mm

Waterproof End Cap-Top

ANFZ1220A10

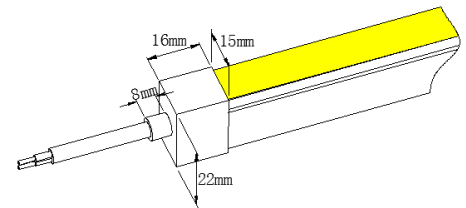
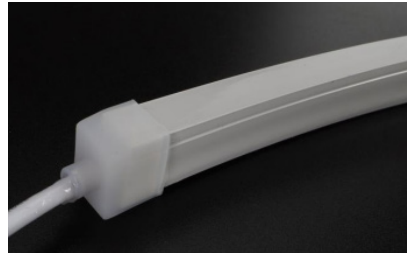

Waterproof End Cap-Right

ANFZ1220A11

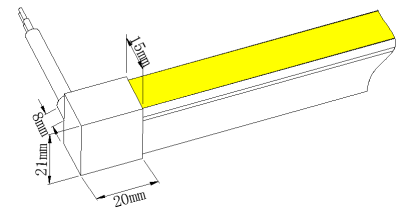
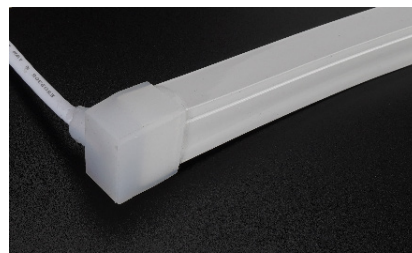

Waterproof End Cap  
-Injection-moulded

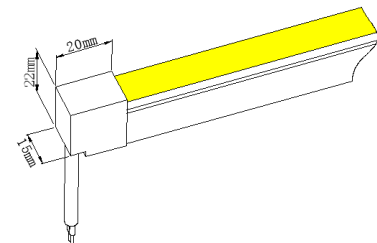

Waterproof End Cap  
-Injection-moulded

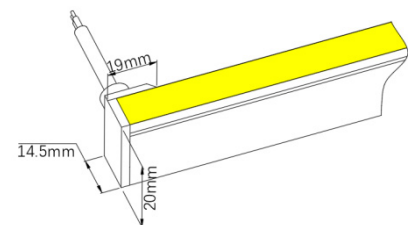

Waterproof End Cap  
-Injection-moulded

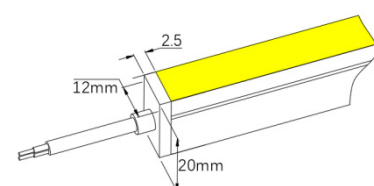

Note: To avoid damage from the excessive force on cable joint, please keep at least 60mm of cable ahead in the natural state.

## Install aluminum clips

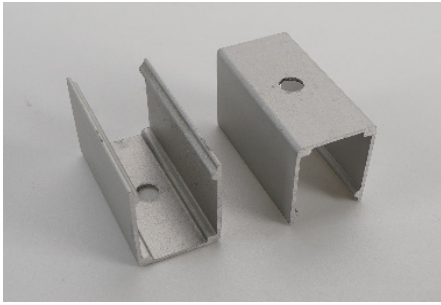

It uses high-quality 6063 aluminum with thin-wall, lightweight design to fit tightly the light body. It is deformation and rust resistant, and cost-effective.

Please refer to the applicable installation ways.

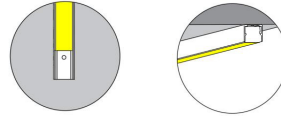

Dimension: mm

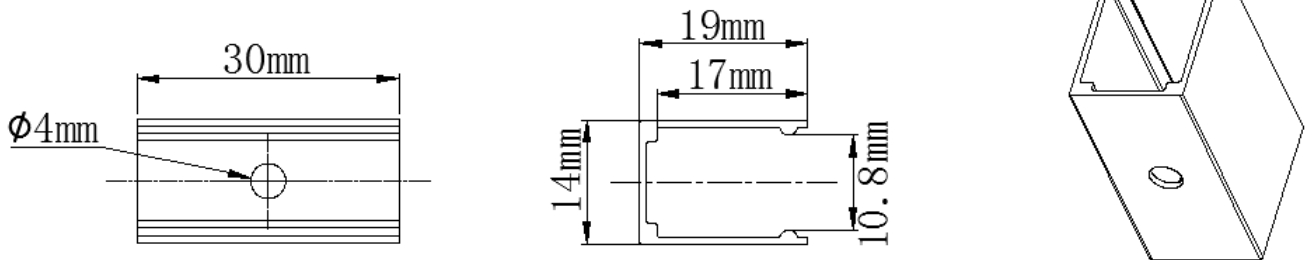

Item Code	Standard Length	Slotted Hole	Hole Number
ANFZ1220A04	30mm/1.18in	Ø4mm/Ø0.16in	1

## Install aluminum clips kit



It uses high-quality 6063 aluminum with thin-wall, which can make the neon evenly stressed, has good compatibility, does not shift, does not fall off, is easy to install and disassemble. It is deformation and rust resistant, and cost-effective.

Please refer to the applicable installation ways.

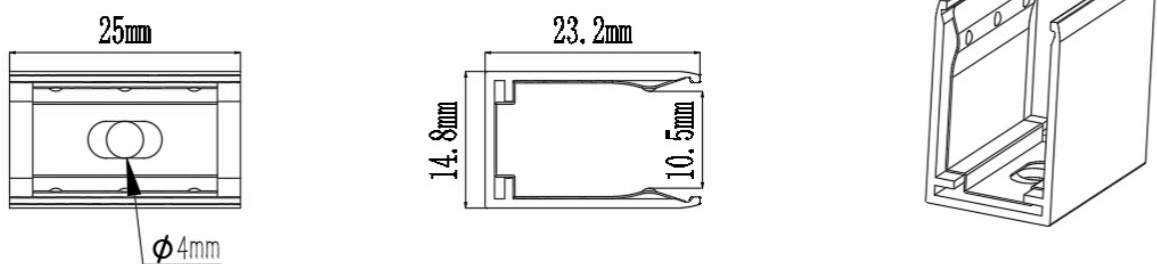
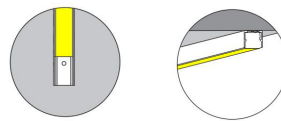

Item Code	Standard Length	Slotted Hole	Hole Number
ANFZ1220A02	25mm/0.98in	Ø3.5mm/Ø0.14in	1

## Aluminum Profile

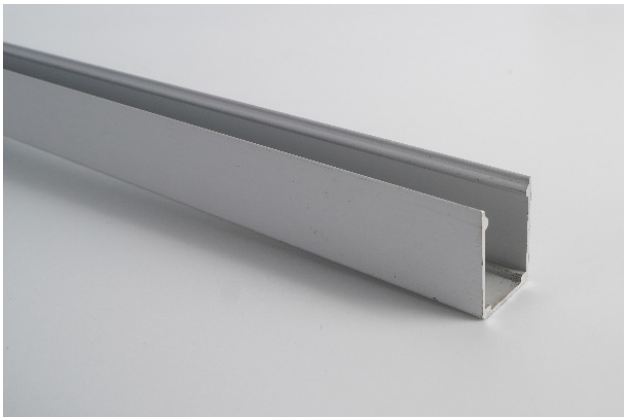

It uses high-quality 6063 aluminum with thin-wall, light-weight design to fit tightly the light body. It is deformation and rust resistant, and cost-effective.

Please refer to the applicable installation ways.

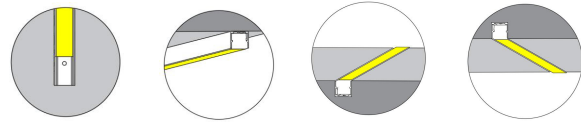

Dimension: mm

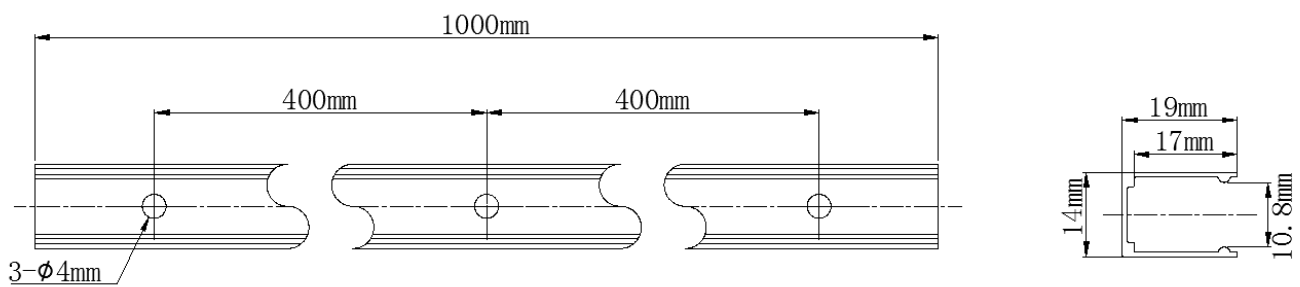

Item Code	Standard Length	Slotted Hole	Hole Number
ANFZ1220A03	1000mm/39.4in	Ø4mm/Ø0.16in	3

## Aluminum Profile Kit



It uses high-quality 6063 aluminum with thin-wall, which can make the neon evenly stressed, has good compatibility, does not shift, does not fall off, is easy to install and disassemble. It is deformation and rust resistant, and cost-effective.

Please refer to the applicable installation ways.

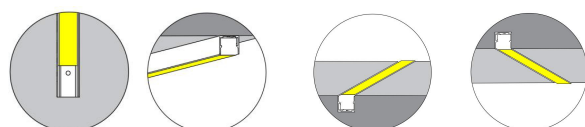

Dimension: mm

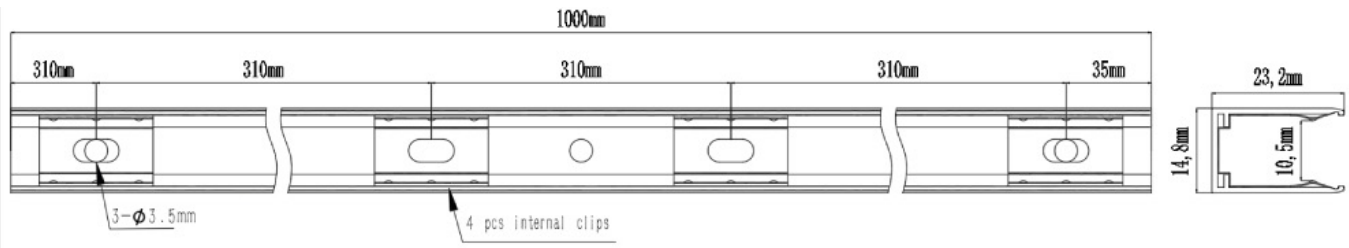

Special precautions: The Installation profile has four internal clips. The profile has three installation holes equipped with three installation screws. The four internal clips are evenly distributed inside the installation profile (as shown in the figure). At both ends, screws are used to fix the internal clips and the profile together on the installation surface. For the middle hole, only a screw needs to be fixed. The two internal clips in the middle no need to be fixed with screws. If the internal clips are displaced, they can be moved to their correct positions.

Item Code	Standard Length	Slotted Hole	Hole Number
ANFZ1220A01	1000mm/39.4in	Ø3.5mm/Ø0.14in	3

## Bendable Serrated Profile



It is an expanded design of the serrated profile, and caters for the continuously streamlined aesthetics of curve shape. The secondary precision cutting process, not only maintains the advantage of clamping force, but also enables the two-way horizontal bending directions with super shape memory.

Please refer to the applicable installation ways.

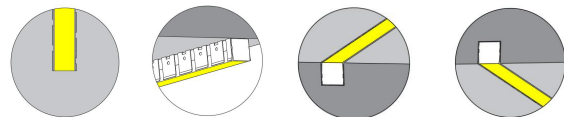

Dimension: mm

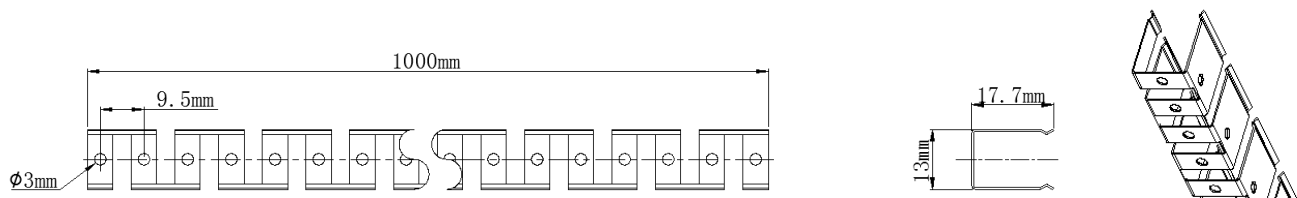

Item Code	Standard Length	Slotted Hole	Hole Number
ANFZ1220A06	1000mm/39.4in	Ø3mm/Ø0.12in	106

## Installation Instructions

Friendly Reminder: please read instructions carefully before operation.

### Installation

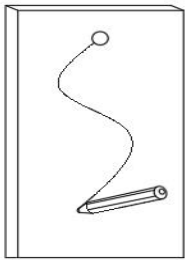

Mark the required shape on the mounting surface or print the sketch in the scale of 1:1 if complicated.

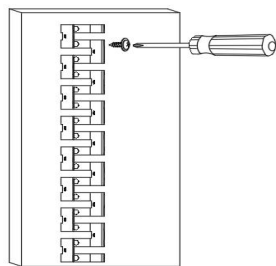

Get the front connector outside of profile and keep at least 10mm more apart. Fix the screw starting from the power input end.

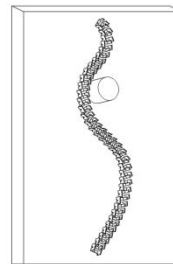

Use cylinder or disc-like object you have to assist with shaping.

### Bending Diameter

Min. Bending Diameter

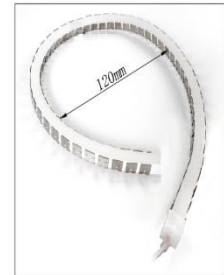

Fix the rest in sequence along with the marks.



Adjust the serrate silicone tape and remove the redundant lengths at both ends



Finish and fix the light in.

### Profile Installation

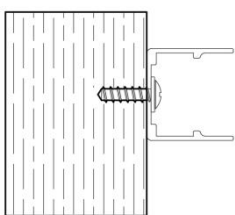

Install the screw into position and ensure the screw head is in line with or lower than the base of aluminum profile.

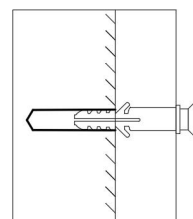

Place the rubber expansion bolt to assist with the screw fixation if the mounting surface is rigid.

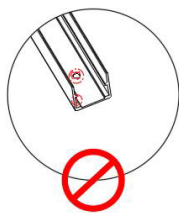

**Make sure no debris in the profile before installation to avoid the light housing being impaled and cause water ingress.**

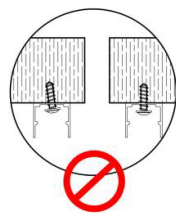

Make sure no bulges on the slot to avoid the damage on the light and cause water ingress.

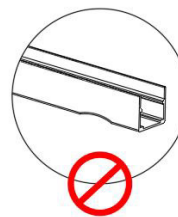

Do not use the profile deformed seriously.

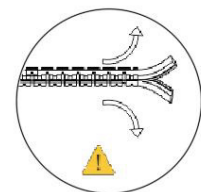

It's recommended to mount in place at a time when using the bendable aluminum profile in case of any break due to the frequent repeated shaping.

## Profile Jointing

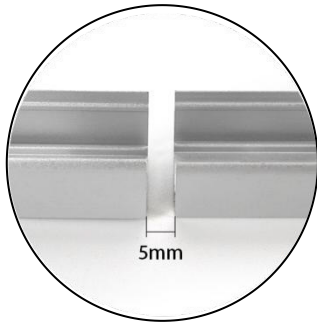

1. Please reserve at least 5mm for profile jointing to enable enough space for contraction and expansion.

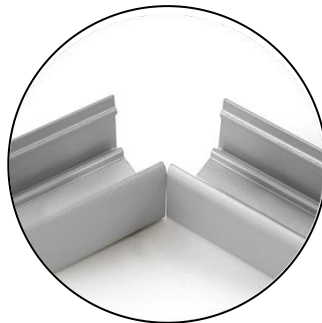

2. The profile can be jointed to a right angle only if there are two pieces of lights connected to be a right angle.



3. For the curve shaping of light, make sure to leave enough space to separate profiles in between or use the bendable profile instead.

### 4. Splice Structure on Mounting Surface



Angular Misalignment



Parallel Vertical Misalignment



Parallel Horizontal Misalignment



In the case of an outdoor mounting surface with the splice structure, please make sure the mounting profile goes across the gap or separate the light and profile as per the splice structure.



When the profile jointing lies where the mounting surface splices, contraction and expansion of the mounting surface in the long term will cause the misalignment of profiles and lights, and lead to the damage of inside PCB.

Above wrong misalignments will make the light improperly bent, and lead to the wrinkle or fracture on PCB.

## Light Installation

It's not recommended to install the light repeatedly, otherwise the light inside might be damaged.

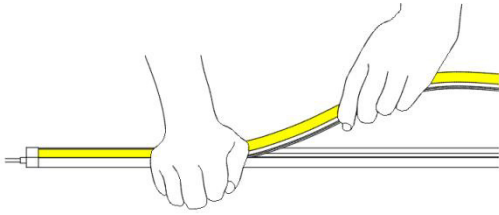

Make sure the light is fitted in vertically.

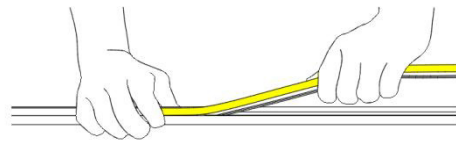

Press the light into the profile by the palm instead of the finger, otherwise it might damage inside electronic components due to the overpressure caused.

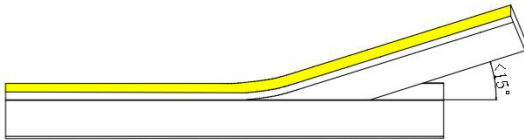

Make sure the angle between the light and profile is not bigger than 15°, otherwise inside PCB might be damaged.

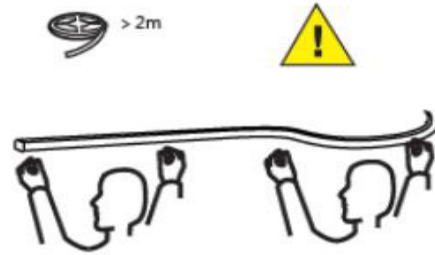

When light length >2m, make sure somebody helps to lift the light, in case the heavy weight of light itself generates too small bending angle or twisting, which may damage inside PCB.

## Light Uninstallation

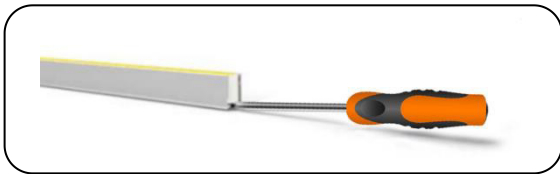

Prepare a screwdriver, and put the screwdriver at the bottom of light.



Move the screwdriver and unclench the light upwardly. Be careful the angle between the light and profile should not be bigger than 15°.

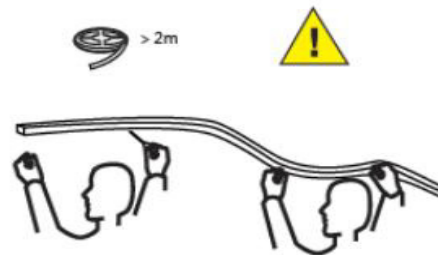
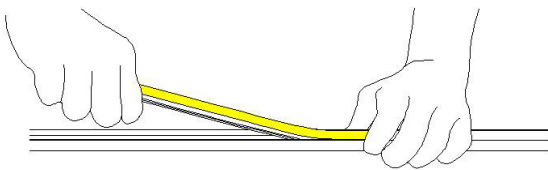

Once the end of light is out, hold both sides of light by hand and pull it out along the profile slowly and orderly. Make sure the angle between the light and profile is not bigger than 15°, otherwise inside PCB might be damaged.

When light length >2m, make sure somebody helps to lift the light, in case the heavy weight of light itself generates too small bending angle or twisting, which may damage inside PCB.

